



Fanless Embedded System



JBC390F541 - Series

## ◎ Specifications :





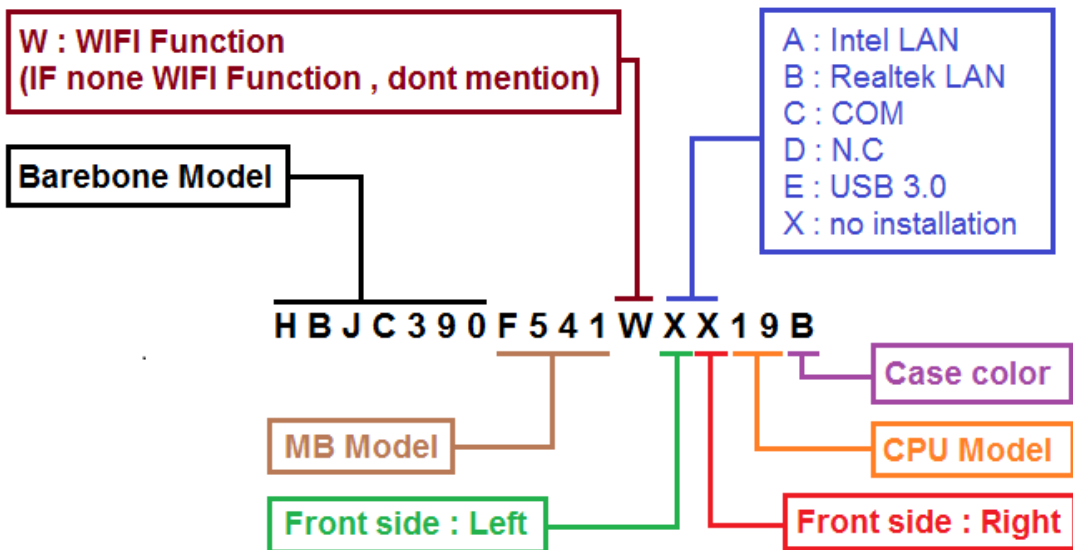
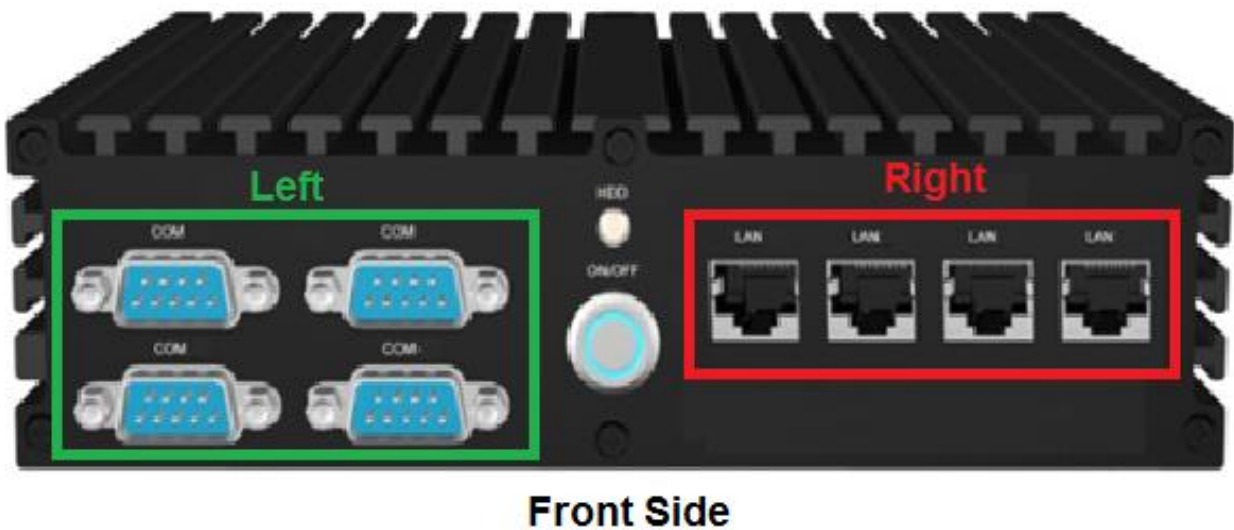

■ <b>Product Dimension</b>	■ 185 (W) * 165 (D) * 48 (H) mm
■ <b>Product Model</b>	<ul style="list-style-type: none"> <li>■ JBC390F541XX19B ( no Expansion Card )</li> <li>■ JBC390F541AA19B ( 8 LAN )</li> <li>■ JBC390F541CC19B ( 8 COM )</li> <li>■ JBC390F541CA19B ( 4 COM + 4 LAN )</li> </ul>
■ <b>MB Model &amp; Size</b>	■ JNF541-1900
■ <b>BIOS</b>	■ AMI UEFI
■ <b>CPU</b>	■ INTEL® Bay Trail-D J1900 SoC Processor
■ <b>Memory</b>	■ One CH SO-DIMM / DDR3L 1333/1066MHz (Max. up to 8GB )
■ <b>Storage</b>	<ul style="list-style-type: none"> <li>■ 2.5" SATA Device (SATA-22P) * 1</li> <li>■ m-SATA SSD * 1</li> </ul>
■ <b>Colors</b>	■ Black
■ <b>Front I/O Port</b>	<ul style="list-style-type: none"> <li>■ Power SW * 1</li> <li>■ HDD LED * 1</li> <li>■ COM</li> <li>■ Intel Giga LAN</li> </ul>
■ <b>Rear I/O Port</b>	<ul style="list-style-type: none"> <li>■ USB3.0 * 1 , USB2.0 * 3</li> <li>■ VGA * 1 , HDMI * 1</li> <li>■ Giga LAN * 2</li> <li>■ MIC * 1 , Line out * 1</li> <li>■ COM * 1</li> <li>■ DC-in Jack * 1</li> <li>■ Reset SW * 1</li> <li>■ WiFi Port * 2 (optional)</li> </ul>
■ <b>Power Source</b>	■ AC 90~240V / 60W / DC-12V Adapter / Lock
■ <b>Expansion Interface</b>	■ Mini PCI-E * 2 (Full-size)

<ul style="list-style-type: none"> <li>■ <b>Packing</b></li> </ul>	<ul style="list-style-type: none"> <li>■ Net Weight : 2.4KG</li> <li>■ Gross Weight : 3.4KG</li> <li>■ Color Box Dimension : 250 (W) x 118 (D) x 295 (H) mm</li> </ul>
<ul style="list-style-type: none"> <li>■ <b>Temperature</b></li> </ul>	<ul style="list-style-type: none"> <li>■ Operating within 0~60 centigrade</li> <li>■ Storage within -10~70 centigrade</li> </ul>
<ul style="list-style-type: none"> <li>■ <b>Certification</b></li> </ul>	<ul style="list-style-type: none"> <li>■ EMC : CE , FCC</li> <li>■ Safety : RoHS , ErP</li> </ul>
<ul style="list-style-type: none"> <li>■ <b>Applications</b></li> </ul>	<ul style="list-style-type: none"> <li>■ Industrial Control System</li> <li>■ Networking Server System</li> </ul>
<ul style="list-style-type: none"> <li>■ <b>Warranty</b></li> </ul>	<ul style="list-style-type: none"> <li>■ 2 Year limited warranty</li> </ul>

© JBC390F541 Model code guide:



◎ External I/O :

Model number	Front - IO
JBC390F541XX19B	
JBC390F541XA19B	
JBC390F541CX19B	
JBC390F541CA19B	
JBC390F541AA19B	
JBC390F541CC19B	

**Rear - IO**

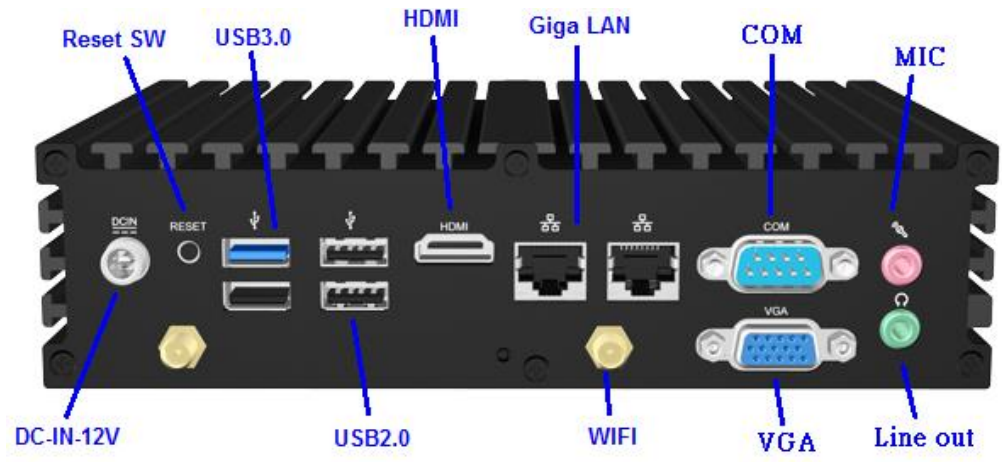

◎ Internal configuration :

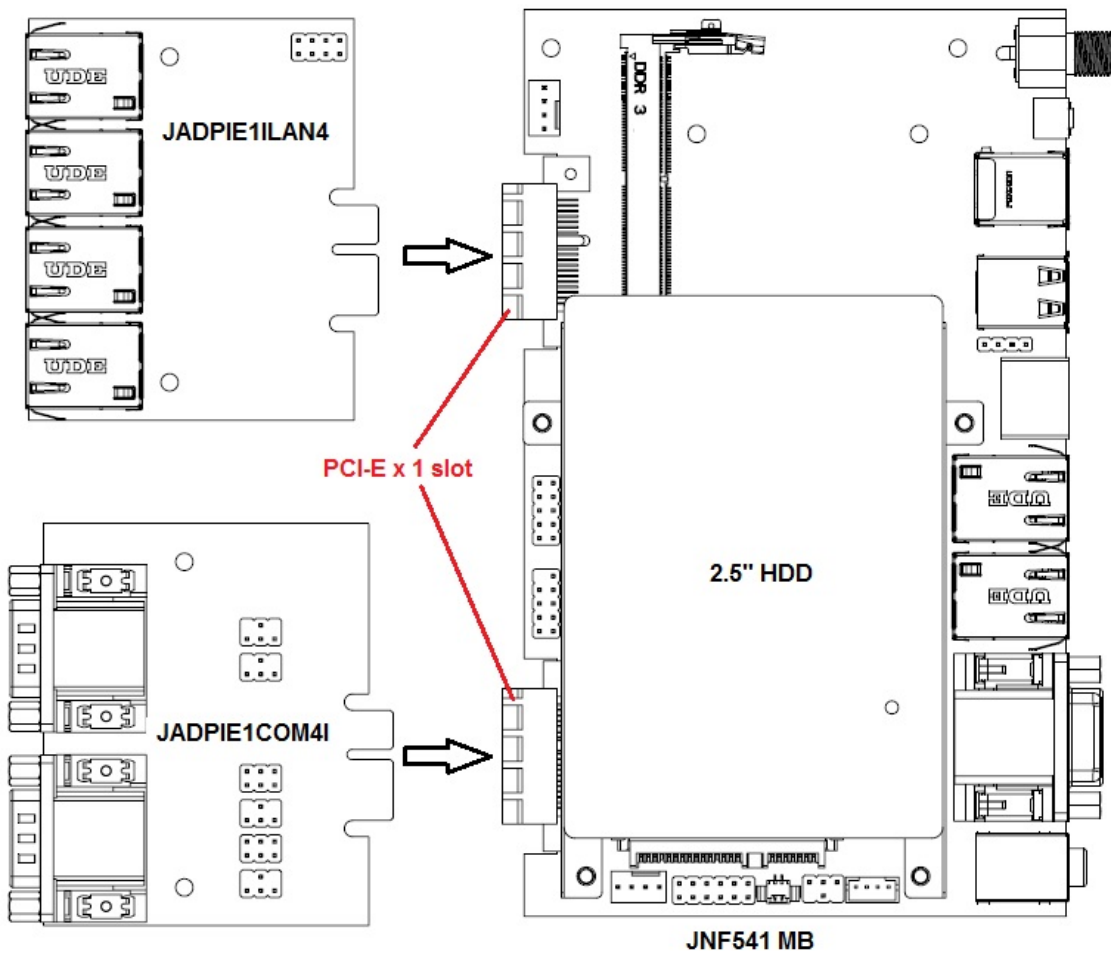

◎ PCI-E Expansion Module:

PCI-E Expansion Module					
NO	Expansion Module	Quantity	JBC390F541 Front side IO metal	Quantity	Explanation
1	JADPIE1ILAN4	1	N.C	0	INTEL LAN module (code : A)
2	JADPIE1COM4	1	N.C	0	COM module (code : C)
3	JADPIE1ILAN4	2	8 ports LAN	1	INTEL LAN module (code : A)
4	JADPIE1COM4	2	8 ports COM	1	COM module (code : C)

◎ Packing List :

<b>Parts Number</b>	<b>Description</b>	<b>Set</b>
G03-JC390QIG01-F	390 Quick Installation Guide	1
G03-NF541-F	NF541 MB User manual	1
G02-DVD20-A10-WF	Mini-ITX INTEL Baytrail DVD Driver	1
L01AS029-F	Adapter 12V/5A 60W Plug Powertron	1
-- --	Power cord	1
LCSCBJC3XX-F	375 Screw Pack	2
HCS370MWM01B-2-F	JC370 Wall mount	2
HCS3XXDINRAILPS-F	DIN RAIL CLIP	2