



HBJC130F533M(W) Series

Intel® Bay Trail-D J1900 Quad Core Processor for Networking Appliance



1. Intel Bay Trail-D Processor
2. 1 * DDR3L 1333/1066MHz Single CH up to 8GB
3. 1* VGA, 1* COM, 3* Mini PCI Express, 6* RJ45(Max), 3* SIM card (Max)
4. M/B Form Factor : 3.5" (148x102mm)
5. DC-12V_5A_60W Adapter



External I/O

Front

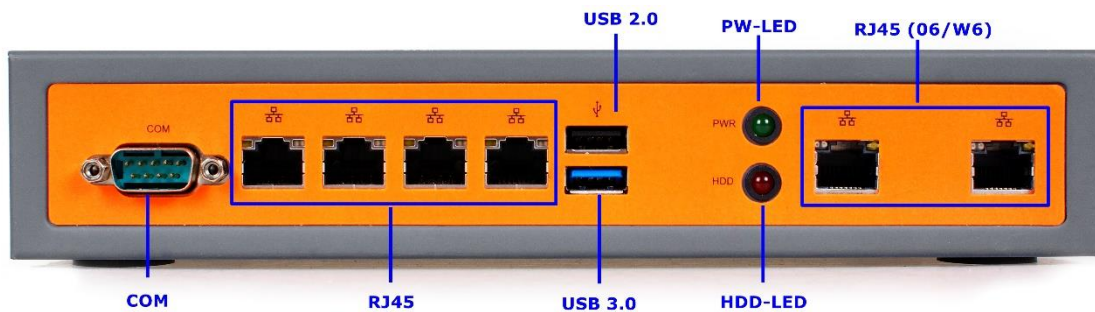

Rear

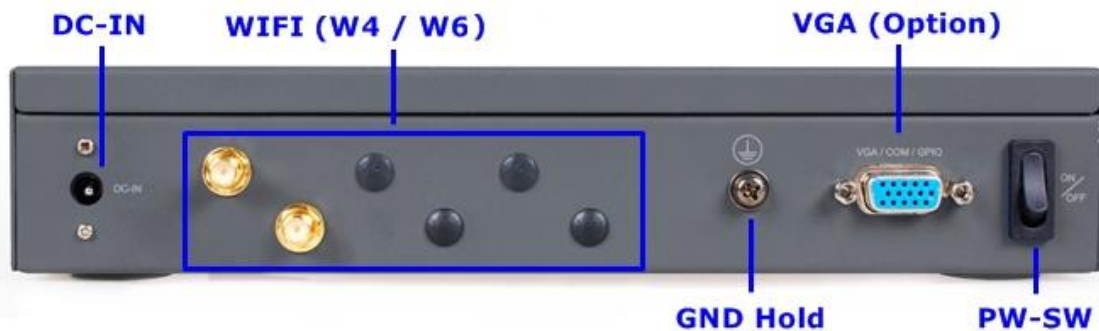







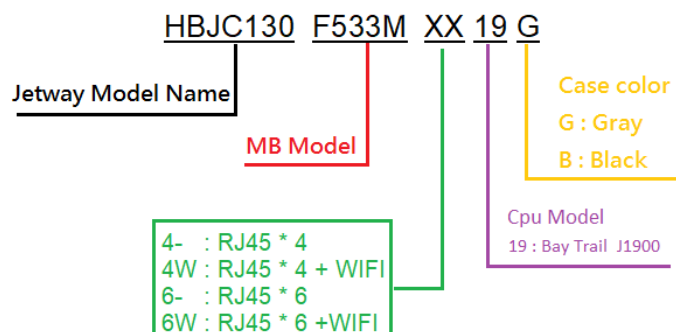

Specifications

MB Model	JNF533MB-1900 / 3.5" SBC
Part No	<ul style="list-style-type: none"> ● HBJC130F533M4-19G / HBJC130F533M6-19G (non-WIFI) ● HBJC130F533M4W19G / HBJC130F533M6W19G (WIFI)
BIOS	AMI 64Mb Flash ROM
CPU	● Intel® Bay Trail Processor J1900 (2.0 GHz) Quad Core
Memory	1* DDR3L 1333/1066MHz Single CH up to 8GB
Expansion	<ul style="list-style-type: none"> ● 2* Mini-PCIe slot (1* full size, 1* half size) ● M.2 (M-key, 2242)
Storage	<ul style="list-style-type: none"> ● 1 * 2.5" SATA HDD ● 2 * USB 2.0 Drive ● 1 * M.2 (M-key, 2242)
Ethernet	● 4 * Intel i211AT GbE
Front I/O Port	<ul style="list-style-type: none"> ● 1 * Power LED ● 1 * HDD LED ● 4 * RJ-45 ● 1 * USB 2.0 ● 1 * USB 3.0 ● 1 * COM
Rear I/O Port	<ul style="list-style-type: none"> ● 1 * PW SW ● 1 * DC- IN ● 6 * WIFI(option) ● 1 * VGA(option) ● 1 * GND Hold
Power Source	● 12V DC-in
Compliance	CE, FCC, RoHS, ErP
Temperature	Operating Temperature: 0~50 °C Storage Temperature: -10~70 °C
Dimensions	232 (W) *152 (D) * 44 (H) mm
Packing	<ul style="list-style-type: none"> ● Net Weight: 1.8KG ● Gross Weight: 2.8KG ● Color Box dimension: 232 (W) x 152 (D) x 44 (H) mm
Warranty	2 Year limited warranty

*Specifications subject to change without notice, not responsible for typographical errors. Does not include HDD or OS.

Part Number Rule



Jetway Model	Front I/O	Rear I/O
HBJC130F533M4-19G		
HBJC130F533M6-19G		
HBJC130F533M4W19G		
HBJC130F533M6W19G		

Mechanical Drawings (Unit = mm)

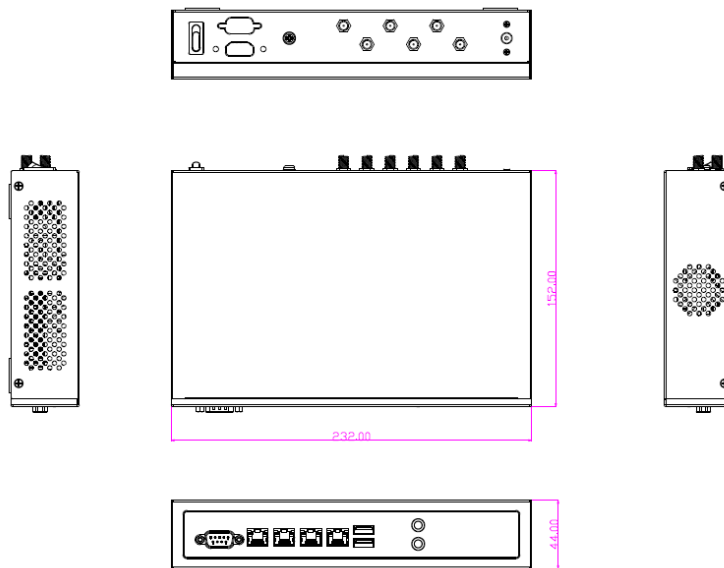

Optional Accessories

Parts Number	Description	Parts Number	Description
-----	HBJC130F533M(W)		User Manual
	AC Cable		CD
	DC-12V/5A Adapter		Screw Package