



HA238SAH-H110-T1

All-In-One System

- Fancy All-In-One system
- INTEL® H110 Express chipset
- Support 1* 10/100/1000Mbps LAN
- Support TPM 1.2
- Integrated HD Audio CODEC with 6.0 CH
- View angle and swivel stand adjustable
- **23.8" PCAP Multi touch Full HD screen**

Introduction

Jetway HA238SAH-H110-T1 is a fancy All-In-One system, equipped with INTEL® H110 Express chipset, up to 1000Mbps LAN speed, also offers DDR4 2133 (Max 32GB) system memory and BIOS of 64MB SPI Flash ROM. OS support Windows 8.1 and 10.

The HA238SAH-H110-T1 is view angle and swivel lift stand adjustable. Forward tilt is -5 to -2 degree; backward tilt is 20 to 23 degree; clockwise is 90 degree. The vertical swivel lift range is 130mm+/-5. Jetway AIO system provides more convenience and flexibility.

The space-saving design of HA238SAH-H110-T1 fits perfectly into office and with the optional purchasable VESA-mount (100*100mm or 75*75mm), it is easily possible to mount it onto walls.

Jetway HA238SAH-H110-T1 is an ideal AIO system choice not only for business application but also for personal use.



Specifications

Model	HA238SAH-H110-T1
Viewable Size Image	23.8 inch With LED Backlight
Active Area	527.04(H) x296.46(V)
Touch Support	Yes (PCAP Multi point touch)
Resolution	1920 x 1080 @60Hz
Display Color	16.7M
Pixel Pitch	0.274 x 0.274 mm
Aspect Ratio	16:09
Contrast Ratio	3000:1
Viewing Angle(H/V)	H178/V178
Response Time	24ms
M/B Form Factor	Thin Mini ITX
Processor	INTEL® LGA1151 series Processor
System Chipset	INTEL® H110 Express Chipset
System Memory	Supports DDR4 SO-DIMM 2133MHz Memory, up to 32GB
BIOS	64MB SPI Flash ROM
Ethernet	1* 10/100/1000Mbps LAN
Audio	Realtek® ALC662 HD Audio
Storage	2* Serial ATA3 6Gb/s connectors
	1* M-SATA connector
WIFI Module	IEEE 802.11 b/g/n supported
TPM	Supports TPM 1.2
Expansion	PCI-E mini card for WLAN
Display Output	DP+HDMI
I/O Port	1*DC-in Jack、4*USB3.0、2*USB2.0、1*GbE、1*DP、
	1*HDMI、Line-out + MIC
Power Adapter	DC-IN 19V
OS Support	Skylake CPU support Win7, Win8, Win10. Kabylake CPU only support Win10.
Temperature Range	0~ +50℃ (Operating)
Humidity	20%~90% (non condensing)
Certification	FCC, CE, RoHS

Mechanical

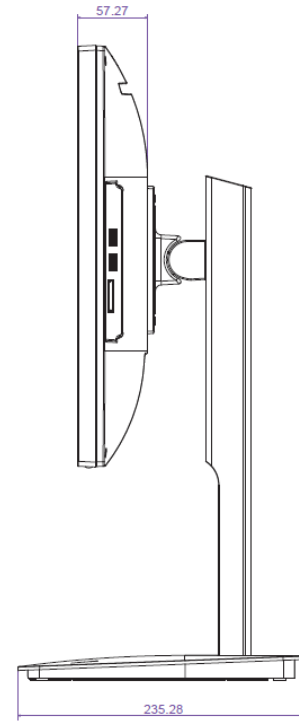
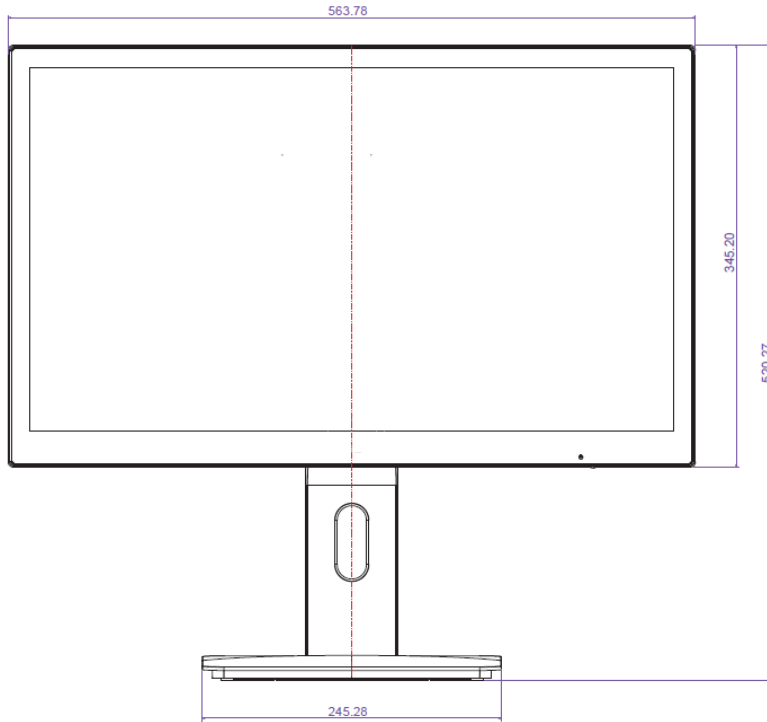

Pivot function: The screen of the All-In-One PC is 90 degree rotatable

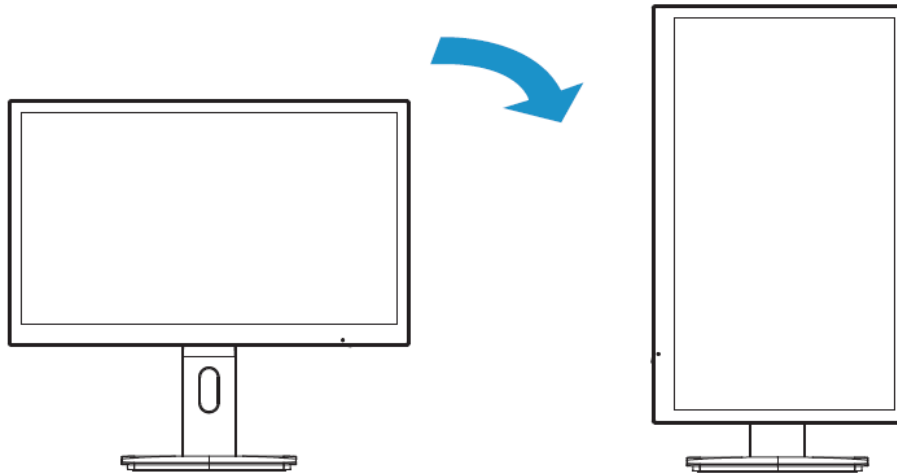

To adjust the image alignment, press one of the following shortcuts:
<Ctrl> + <Alt> + <up>, for normal view
<Ctrl> + <Alt> + <left>, for rotated view

Adjustment of view angle

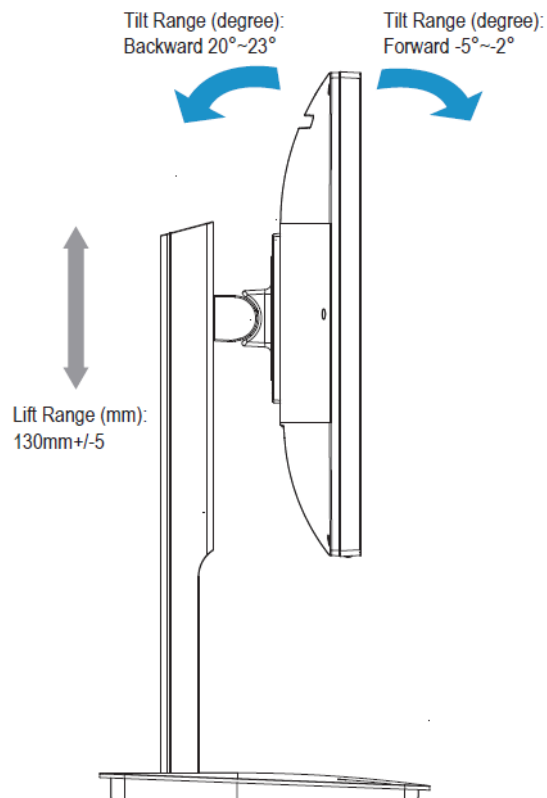



Right-side View

Bottom-side View

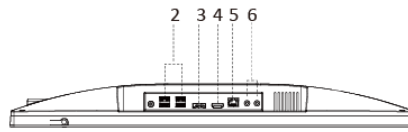
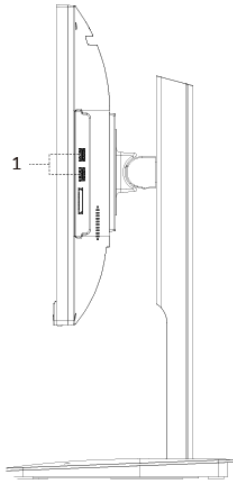

- 1. 2*USB2.0 Ports
- 2. 4*USB 3.0 Ports
- 3. 1*DisplayPort
- 4. 1*HDMI Port
- 5. 1*RJ45 Port
- 6. 1*Line-out & 1* MIC

Box Contents

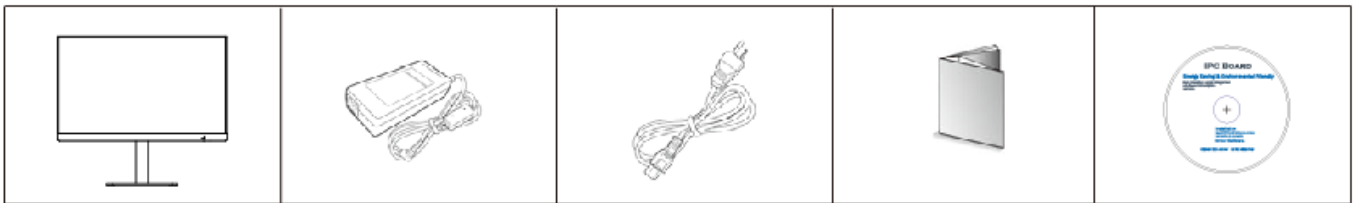

HA238SA-H110-TH

19V, 120W
AC-DC Adapter

Power Cord

User Manual

CD